

OPERATION, PARTS AND SAFETY MANUAL



SIGNODE®

SCM-12/58/34
MANUAL COMBINATION STRAPPING TOOL

IMPORTANT!
DO NOT DESTROY

**It is the customer's responsibility to
have all operators and servicemen
read and understand this manual.**

Contact your local Signode representative
for additional copies of this manual.

READ ALL INSTRUCTIONS BEFORE OPERATING THIS SIGNODE PRODUCT

SIGNODE • 3620 WEST LAKE AVENUE • GLENVIEW, ILLINOIS 60025 U.S.A.

WARNING

READ THESE INSTRUCTIONS CAREFULLY.

FAILURE TO FOLLOW THESE INSTRUCTIONS CAN RESULT IN SEVERE PERSONAL INJURY.

GENERAL SAFETY CONSIDERATIONS

1. STRAP BREAKAGE HAZARD.

Improper operation of the tool or sharp corners on the load can result in strap breakage during tensioning, which could result in the following:

- A sudden loss of balance causing you to fall.
- Both tool and strap flying violently towards your face.

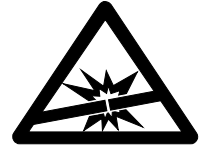

Failure to place the strap properly around the load or an unstable or shifted load could result in a sudden loss of strap tension during tensioning. This could result in a sudden loss of balance causing you to fall.

Read the tool's operating instructions. If the load corners are sharp use edge protectors. Place the strap correctly around a properly positioned load.

- Positioning yourself in-line with the strap, during tensioning and sealing, can result in severe personal injury from flying strap or tool. When tensioning or sealing, position yourself to one side of the strap and keep all bystanders away.

2. TRAINING.

This tool must not be used by persons not properly trained in its use. Be certain that you receive proper training from your employer. If you have any questions contact your Signode Representative.

3. EYE INJURY HAZARD.

Failure to wear safety glasses with side shields can result in severe eye injury or blindness. Always wear safety glasses with side shields which conform to ANSI Standard Z87.1 or EN 166.



4. FALL HAZARD.

Maintaining improper footing and/or balance when operating the tool can cause you to fall. Do not use the tool when you are in an awkward position.

5. CUT HAZARD.

Handling strap or sharp parts could result in cut hands or fingers. Wear protective gloves.



6. TOOL CARE.

Take good care of the tool. Inspect and clean it daily, lubricate it weekly and adjust when necessary. Replace any worn or broken parts.

7. WORK AREA.

Keep work areas uncluttered and well lighted.

⚠ WARNING

8. OPERATING SEQUENCE.

Use the correct Signode products for your application. If you need help contact your Signode Representative. Before using this sealless tool, read the Operation and Safety Instructions contained in this manual.

9. JOINT FORMATION

Sealless joints are formed when overlapping straps are punched simultaneously creating interlocking keys. However, the integrity of the joint is obtained when the keys punched in the upper strap move in relation to the keys on the bottom strap, allowing the straps to interlock. The movement necessary to create the interlock comes from the strap tension release where the top strap moves one direction and the bottom strap moves in the other direction. Therefore, never attempt to make a sealless joint without having the straps under tension.

This tool is a punch type sealer. A properly formed joint will appear as shown in the illustration. If the joint does not appear as shown, then the operator must proceed as follows:

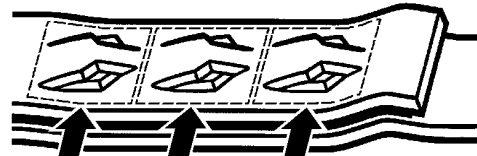

- A. Ensure that the tool's operating instructions are being followed before applying another strap.
- B. Ensure that tension has been applied to the straps before the sealer handle is activated. Tension is necessary to ensure that the keys fully interlock.
- C. After confirming the above cut the strap off and apply another.

If the joint still does not appear as shown, then inspect the tool for worn and/or damaged parts. Replace tool parts as needed. **NEVER HANDLE OR SHIP ANY LOAD WITH IMPROPERLY FORMED JOINTS.** Misformed joints may not secure the load and could cause serious injury.

Always tuck the strap end back into the dispenser when not in use.

10. CUTTING TENSIONED STRAP

Using claw hammers, crowbars, chisels, axes or similar tools can cause tensioned strap to fly apart with hazardous force. Use only Signode cutters designed for cutting strap such as the Model CU-30. Read the instructions in the cutter's manual for proper procedure in cutting strap. Before using any Signode product read its Operation and Safety Manual.

TABLE OF CONTENTS	Page
General Safety Instructions	2
Introduction	4
Specifications	5
Major Components	5
Operating Instructions	6
Strap Joint Formation & Appearance	8
Adjustments	9
Parts List	10
Troubleshooting	13
Changing Strap Sizes	16
Tool Options	18
Declaration Of Conformity	19

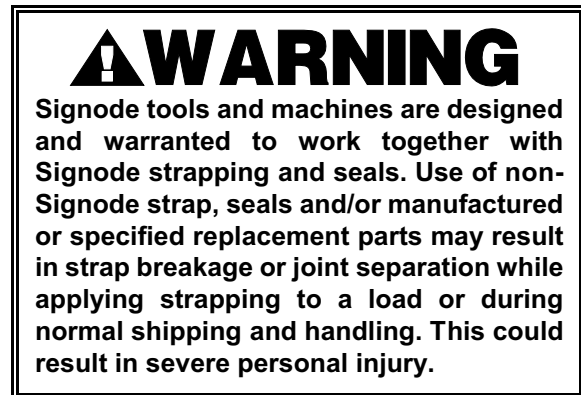

INTRODUCTION

The SCM is a light weight, manually operated hand tool intended for use with Apex and Magnus strapping. The tool is easy to load, tension and seal.

Once the strap has been placed around the package, the operator puts both layers of strap into the tool, lowers the feed wheel, removes any strap slack and tensions the strap. The keyed sealless joint is then created and the strap is cut free of the supply.

This manual provides the information necessary for the operation of the SCM hand tool and lists all of the parts in the event maintenance is needed. Therefore, it is valuable and should be saved.

Extra care should be taken in performing maintenance on the SCM since fasteners and other small components used on this tool are a combination of SAE and metric sizes.

SPECIFICATIONS

TOOL MODEL		STRAP		
		TYPE	WIDTH	THICKNESS
SCM-12	P/N 424350	Apex & Magnus	1/2" (12.7mm)	0.015 - 0.025" (0.38 - 0.64mm)
SCM-58	P/N 424358		5/8" (15.9mm)	
SCM-34	P/N 424334		3/4" (19.1mm)	

MAJOR COMPONENTS

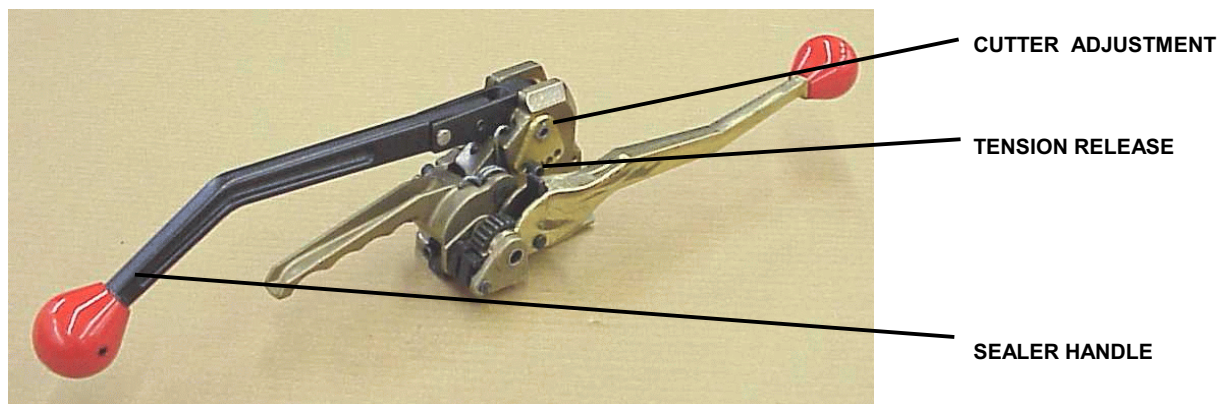
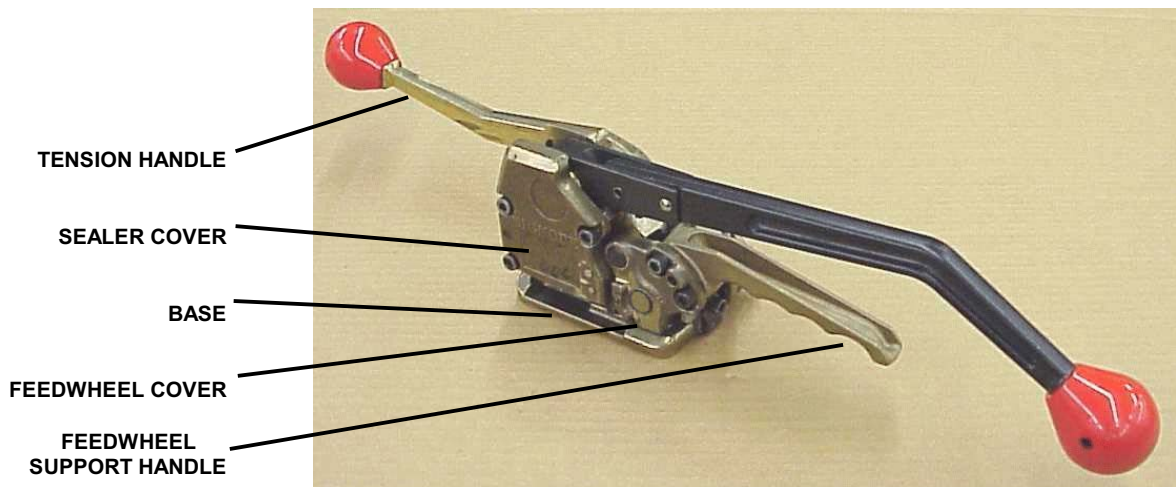

OPERATING INSTRUCTIONS

WARNING

**Wear safety glasses. Stand to one side of the strap while tensioning.
Make sure all bystanders are clear before proceeding.**

1. STRAP PREPARATION.

Encircle the package with strap by passing the loose end over the top and bringing it back around. This will result in a top strap and a bottom strap.

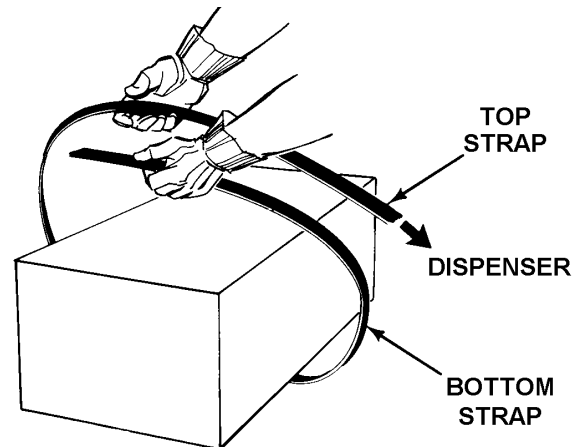

2. **TOP AND BOTTOM STRAP INSERTION.** Squeeze the sealer handle and the feedwheel support handle together with the right hand. With the left hand, align the top and bottom straps. Then, with a sideways motion, insert them into the tool, making sure both straps are fully seated in and against the front and back strap guides. Note that both straps must be placed between the feed wheel and the clutch plug. Make sure the lead end of the bottom strap extends about 1" to 1 1/2" (25 - 40mm) beyond the front of the tool.

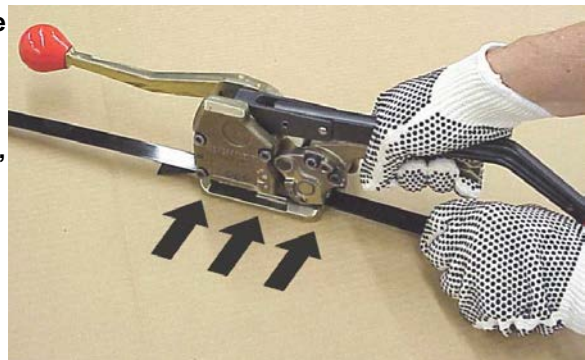

3. **REMOVING SLACK STRAP.** After the straps have been inserted into the tool, release the feedwheel support handle. With the left hand, grasp the top strap and pull back on it to remove slack strap. Pull it snug around the package. The feed wheel will rotate as the strap is being pulled back.

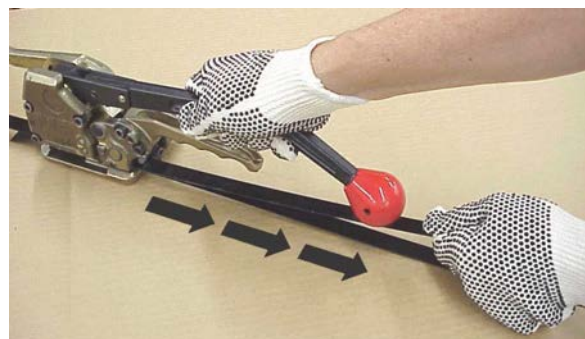

4. **APPLYING TENSION.** While standing to one side of the strap line, grasp the tension handle with the right hand and the sealer handle with the left hand. Move the tension handle forward and back between the 11 o'clock and 2 o'clock positions repeatedly, until the strap is tensioned around the package.

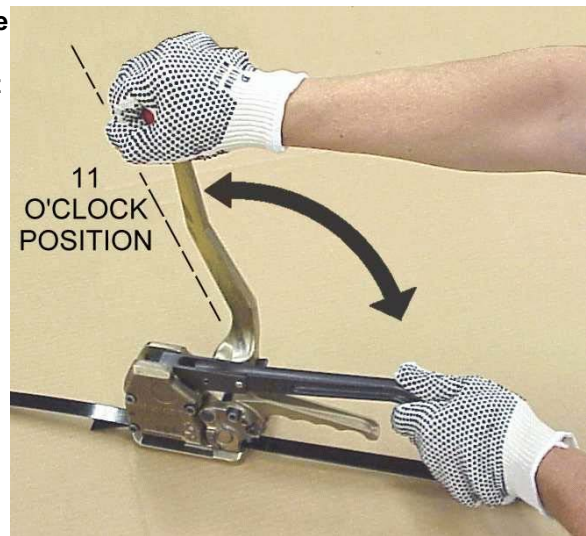

! WARNING

Never push the tension handle all the way forward past the 11 o'clock position as the feedwheel will lift and the tensioned strap will release from the tool.

Never squeeze the feedwheel support handle and sealer handle together while tensioning strap.

5. **SEALING THE STRAPS.** After the strap has been tensioned, grasp the sealer handle with the left hand. Move the sealer handle fully forward while pulling back on the tension handle to punch completely through both layers of strap.

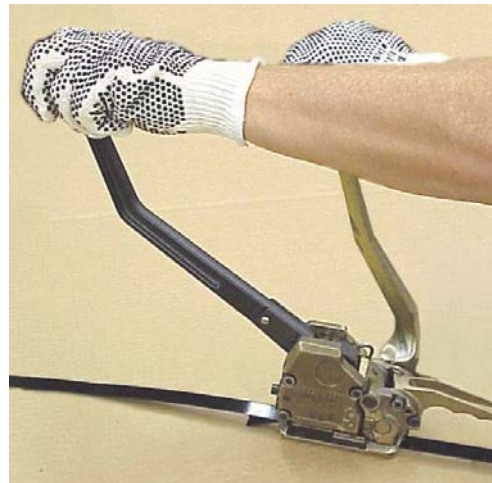
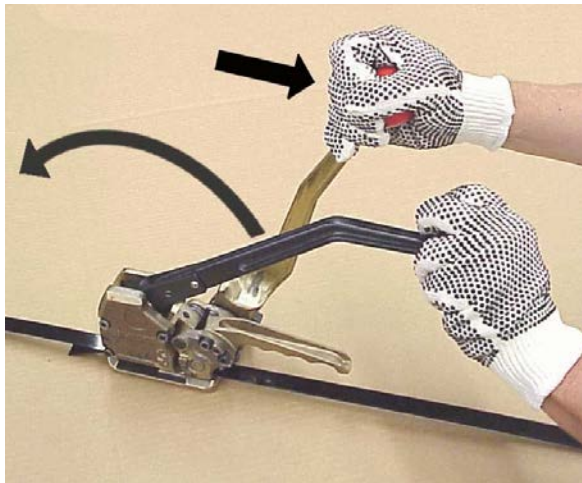

NOTE: If the sealer handle is not cycled fully forward the strap will not be completely punched or cut off. If this occurs the tool cannot be removed from the tensioned strap. To remove the tool cycle the sealer handle completely forward a second time. If the tool still fails to completely cut or punch the straps, cut the straps and tool from the package. Check the tool for worn or broken parts. Inspect the strap joint for proper formation of interlocking keys.

OPERATING INSTRUCTIONS, Continued

6. **REMOVING THE TOOL.** Hold the cut-off end of the top strap with the left hand and squeeze the feedwheel support handle and the sealer handle together with the right hand. Swing the rear end of the tool to the right to remove it from the tensioned tie. The strapping cycle is now complete. Inspect the strap joint for proper formation by reviewing Joint Appearance and Formation below.

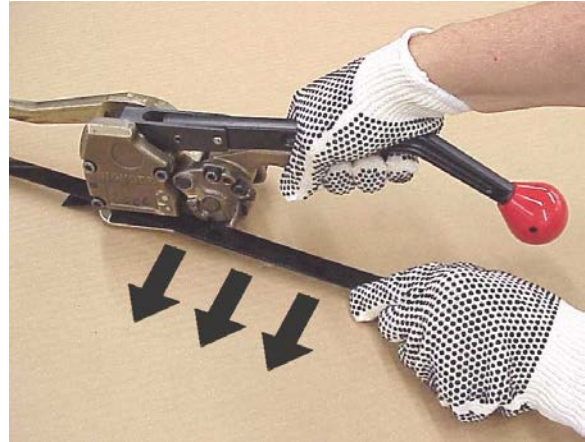

STRAP JOINT APPEARANCE & FORMATION

A properly formed joint will appear as shown in the following illustration.

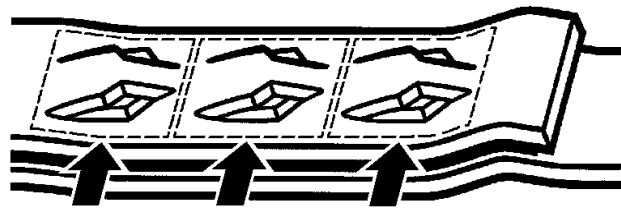

WARNING

If the joint does not appear as shown, then the operator must proceed as follows:

- Make sure that the tool's operating instructions are being followed before applying another strap.
- Make sure that tension has been applied to the straps before the sealer handle has been actuated. Tension is necessary to ensure that the keys fully interlock.

After confirming the above, cut off the strap and apply another.

If the joint still does not appear as shown, then inspect the tool for worn and/or damaged parts. Replace tool parts as needed.

NEVER HANDLE OR SHIP ANY LOAD WITH IMPROPERLY FORMED JOINTS.

Misformed joints may not secure the load and could cause serious injury.

ADJUSTMENTS

CUTTER

The cutter may have to be adjusted if the tool has been altered to accept a different width or thickness of strap or an adjustment may be needed if the cutter has been replaced due to wear or damage.

Run a cycle with strap of the size to be used. A properly adjusted cutter will sever the top strap completely but the lower strap will have minimal impression, at the most. Excessive scoring of the lower strap is an indication of over cutting and this is not acceptable.

Lay the tool with the strap loading side down, remove the socket head cap screw (SHCS) that attaches the locking plate to the base (it is not necessary to remove the locking plate). Insert a 5.0 mm hex wrench into the end of the eccentric shaft. Rotate the shaft clockwise a few degrees for thinner strap or counterclockwise for heavier strap. There are two mounting holes available for the locking plate. Align the "nearest" hole in the plate to the mounting hole in the base and reinstall the socket head cap screw.

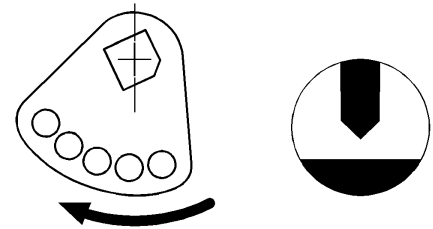
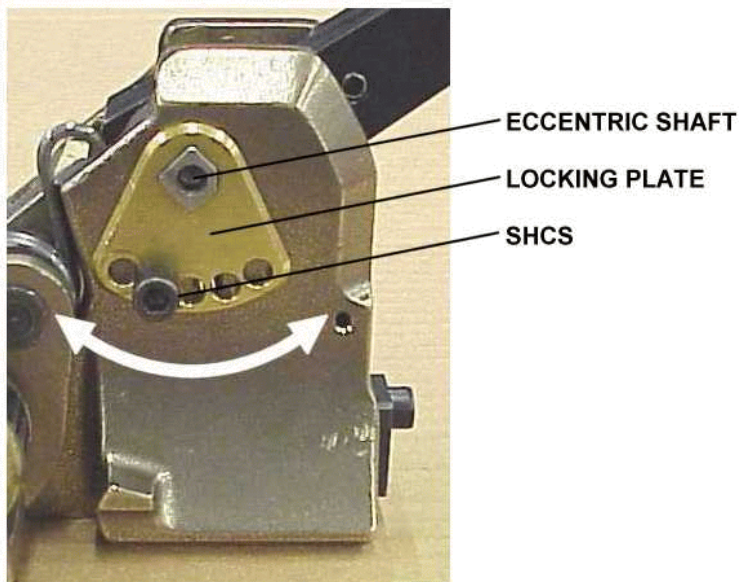

ROTATE THE LOCKING PLATE
CLOCKWISE TO LOWER THE CUTTER
FOR THINNER GAUGE STRAPPING.

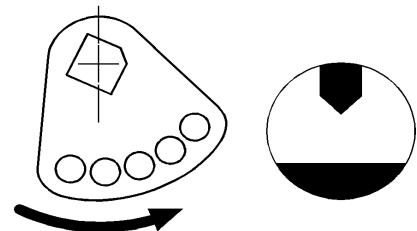

ROTATE THE LOCKING PLATE
COUNTERCLOCKWISE TO RAISE THE
CUTTER FOR HEAVIER GAUGE
STRAPPING.

FEEDWHEEL AND CLUTCH PLUG

There is no adjustment for feedwheel/clutch plug clearance. The clearance should be .001" to .010" (0.025 to 0.25mm). The most important issue is that the feedwheel does not interfere with the clutch plug.

PARTS LIST

<u>KEY</u>	<u>QTY.</u>	<u>PART NO.</u>	<u>DESCRIPTION</u>
1	1	424091	Base
2	1	424245	Back guide
3	1	424244	Front guide
4	3	010032	SHCS M6x12
4A	1	280830	SHCS M6x16 (For use with optional deflector Key 68)
5	8	010077	Lock washer M6
6	3	006045	Roll pin 1/8 x 3/8 long
7	2	424098	Lifter
8	1	424106	Locking plate
9	1	185778	SHSS M6x12
10	1	424241	Energizing spring
11	8	274931	Dowel pin 3 x 12 long
12	2	259935	SHCS M3 x 12
13	4	162568	Lock washer M3
<u>14</u>	<u>3</u>	<u>424300</u>	<u>Punch</u>
15	2	262456	SHCS M3 x 6
16	2	162383	SHCS M4 x 8
17	1	424099	Die support
<u>18</u>	<u>1</u>	<u>424094</u>	<u>Cutter</u>
19	1	424107	Cutter anvil
20	1	426937	Die holder
21	1	426939	Cam roller pin
22	2	424117	Washer
23	1	426938	Cam roller
24	49	426936	Needle roller
25	1	424103	Sealer cover
26	1	424121	Outer guide
27	1	162391	Dowel pin 5x24
28	5	010037	SHCS M6x20
29	1	274047	Dowel pin 6 x 16
<u>31</u>	<u>1</u>	<u>424308</u>	<u>Garlock DU bushing 08DU08 1/2 x 1/2</u>
33	1	253433	Dowel pin 4x14
34	1	424120	Link
<u>35</u>	<u>1</u>	<u>425403</u>	<u>Clutch plug</u>
36	1	002678	O-Ring
<u>37</u>	<u>1</u>	<u>424240</u>	<u>Feedwheel</u>
38	1	424309	Feedwheel spacer
40	1	424083	Feedwheel support
42	1	424247	Holding pawl pin
43	1	424249	Pivot pin
<u>44</u>	<u>1</u>	<u>424307</u>	<u>Garlock DU bushing 06DU04 3/8 x 1/4</u>
45	1	003454	Long retaining pawl
46	1	003455	Short retaining pawl
47	2	003483	Retaining pawl spring
48A	1	183295	Klipring, Truarc 5304-31 (Newer Style)
48B	1	005054	Retaining ring, Truarc 5100-31 (Older Style)
49	1	424317	Tension handle assembly
50	1	003462	Handel pawl
51	1	424246	Handle pawl pin
52	1	003467	Pawl spring
53	1	424108	Ratchet

<u>KEY</u>	<u>QTY.</u>	<u>PART NO.</u>	<u>DESCRIPTION</u>
54	1	426942	Cam/Handle assy (Note-3)
55	1	010054	Knob (Note-3)
56	2	010057	Roll pin 1/4 x 1/ 3/4 (Note-3)
57	2	424303	Cam spacer (Note-3)
58	2	422831	Dowel pin, 4 x 10 (Note-3)
59	1	424079	Eccentric shaft
60	1	274385	Dowel pin 6 x 20
61	1	252247	Dowel pin 5 x 20
65	1	424311	Warning sign
66	1	424312	Nameplate, 1/2
	1	424314	Nameplate, 5/8
	1	424316	Nameplate, 3/4
67	1	286374	Safety sign
68	1	424321	Deflector (Note-6)
69	1	424449	Washer
70	1	423996	Klipring, Truarc 5304-37
80	1	425410	Feedwheel cover sub-assembly
81	1	425375	Outer bearing
82	1	425401	Feedwheel shaft
83	1	306927	Handle Knob

⚠ WARNING

Inspect all parts daily and replace them if they are worn or broken. Failure to do this can affect a product's operation and could result in serious personal injury.

- When ordering parts, please show model, part number and description.
- Standard hardware parts may obtained at any local hardware supply.
- Recommended spare parts are underlined and should be stocked.

NOTES:

1. Locking Plate (Key 8) must be installed with the text "OUT" facing away from base.
2. Outer Guide (Key 26) must be installed with chamfer side out.
3. Key numbers 54 through 58 and Key 24 can be purchased as Part No. 426943.
4. Socket head cap screws (Key 28) which secure the Sealer Cover (Key 25) must be torqued to 85-95 in-lbs.
5. Lubricate all moving parts with Molith No. 2 or Lubriplate 3000W Grease (Signode Part No. 422793).
6. The Deflector (Key 68) is an optional part which is used to prevent the strap from curling around the feedwheel from severe high tension applications. Key numbers 4A, 5, 6 and 68 can be purchased together as Deflector Kit (Signode Part No. 427611). The Back Guide (Key 2) must be used with the deflector kit.
7. Key numbers 31, 33, 60, 80 and 81 can be purchased together as Signode Part No. 425408.
8. Key numbers 6, 35, and 36 can be purchased together as Signode Part No. 425405.
9. Key numbers 20, 21, 22, 23 & 24 can be purchased together as Signode Part No. 426944.

* Use Loctite #242 (Signode Part No. 422795) or equivalent.

** Use Loctite #222 (Signode Part No. 422794) or equivalent.

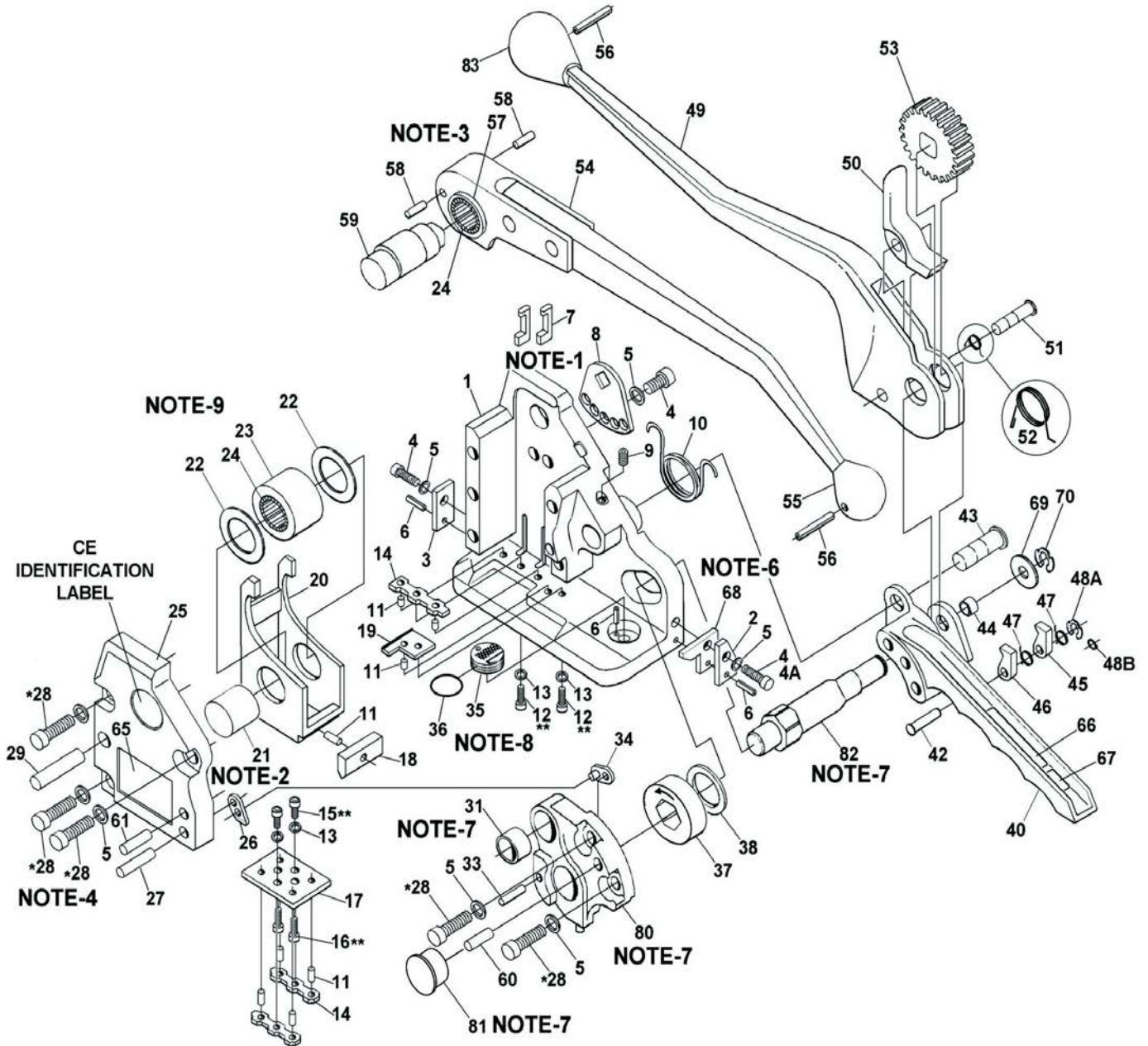

Review page 11 of this manual for explanation of notes.

TROUBLESHOOTING

The following items are the most common tool symptoms if problems should occur. For symptoms or remedies not shown, contact your Signode service representative for additional information and details. The following tool symptoms are shown in this manual:

#1 SYMPTOM: Difficult strap slack removal.

#2 SYMPTOM: Poor tensioning

#3 SYMPTOM: Joint fails after tool is removed or joint not made properly.

#4 SYMPTOM: Excessive effort needed to seal straps together.

#5 SYMPTOM: Tool will cut-off strap after sealing , or bottom strap cut too deep.

#6 SYMPTOM: Tool cannot be removed from strap after cycle is completed.

#7 SYMPTOM: Feedwheel slips during tensioning.

#1 SYMPTOM: Difficult strap slack removal.	
CAUSE	REMEDY
1. Strap not lubricated or not waxed adequately.	1. Purchase only lubricated (waxed) strapping.
2. Strap not inserted properly (strap caught by outer guide)	2. Insert and align straps in tool properly.
3. Damaged parts in tension sub-assembly.	3. Inspect the tension assembly's ratchet wheel and pawls for damage or broken parts.

#2 SYMPTOM: Poor tensioning.	
CAUSE	REMEDY
1. Feedwheel or clutch plug packed with dirt or grit.	1. If top strap is slipping, clean dirt from the feedwheel or replace worn feedwheel if necessary.
2. Feedwheel or clutch plug teeth are worn.	2. If bottom strap is slipping, clean dirt from the clutch plug or replace worn clutch plug if necessary.
3. Strap not properly aligned when inserted into tool.	3. Insert strap into tool carefully aligning strap.

NOTE: Carefully inspect strap applied to determine if top or bottom strap is slipping.

TROUBLESHOOTING, Continued

#3 SYMPTOM: Joint fails after tool is removed or joint does not appear to have been made properly.	
CAUSE	REMEDY
1. Low joint strength caused by chipped or worn sealer parts.	1. Inspect sealing parts for wear or chipped edges.
2. Strap not strong enough to contain load or force exerted by load.	2. Review application to determine proper strapping to use. If necessary contact your Signode sales representative.
3. Joint made on strap that had not been tensioned to a proper level.	3. Make sure that tension is applied to the straps before the sealer handle is operated.
4. Strap not inserted properly- 3 punches must penetrate both straps.	4. Insert straps with bottom strap extending 1" to 1 1/2" (25-40mm) past the front of the tool.
5. Bottom strap being cut by the cutter.	5. Adjust cutter as required.

#4 SYMPTOM: Excessive effort needed to seal straps together.	
CAUSE	REMEDY
1. Broken needles within the sealer handle assembly.	1. Carefully inspect sealer drive for worn or broken parts.
2. Worn dies, punch or cutter.	2. Replace appropriate dies, punch or cutter.
3. Poor tool lubrication.	3. Lubricate eccentric shaft, bearing needles, sealer cam and cam roller.

#5 SYMPTOM: Tool will not cut-off strap after sealing (cannot remove tool) or bottom strap cut too deeply.	
CAUSE	REMEDY
1. Cutter blade damaged or worn. Cut strap manually from package too release tension and de-energize feedwheel.	1. Inspect cutter for wear or damage, replace as necessary.
2. Different gauge (thinner) strap requires cutter adjustment.	2. Adjust cutter blade for gauge of strap being used.

#6 SYMPTOM: Tool cannot be removed from strap after cycle is completed.	
CAUSE	REMEDY
1. Upper strap was not cut off.	1. Inspect both the cutter for damage or adjustment. Cut strap manually from package to release tension and de-energize feedwheel.
2. Chipped or worn parts (punches and dies).	2. Inspect and replace worn sealer parts.

#7 SYMPTOM: Feedwheel slips during tensioning.	
CAUSE	REMEDY
Flat spot on feedwheel.	Replace feedwheel.

CHANGING SCM STRAP SIZE

The following table illustrates the unique parts to a particular strap size for the SCM tool. If the strap size of the tool is to be changed, this table must be used to coordinate all the respective parts which must be reconfigured or replaced.

Follow all specified parts removal, replacement & adjustment procedures found in this manual when changing any of the strap conversion parts.

WARNING

Do not attempt to convert a tool's strap size without replacing/reconfiguring all of the specified parts for the conversion. Failure to replace/reconfigure all required parts may cause severe personal injury.

UNIQUE PARTS & CONFIGURATION TO SCM STRAP SIZES

KEY	QTY	DESCRIPTION	1/2" (12mm)	5/8" (16mm)	3/4" (19mm)
3	1	Front Guide	424244, Note-1	424244, Note-2	424244, Note-2
2	1	Back Guide	424245, Note-3	424245, Note-4	424245, Note-4
26	1	Outer Guide	424121, Note-5	424121, Note-5	424121, Note-6
63	1	Nameplate	424312	424314	424316

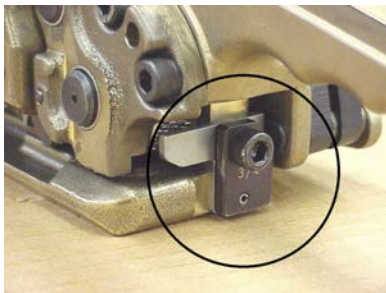

BACK GUIDE

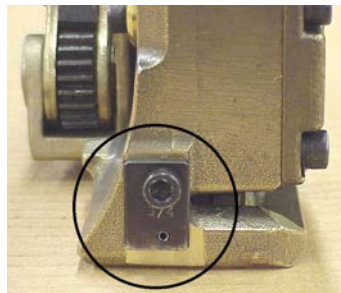

FRONT GUIDE

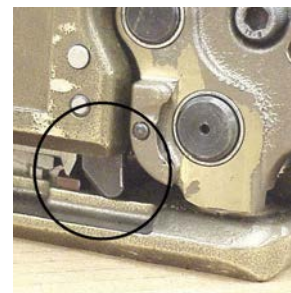

OUTER GUIDE

NOTES:

1. Install guide (Key 3) with text "1/2" facing outward from tool.

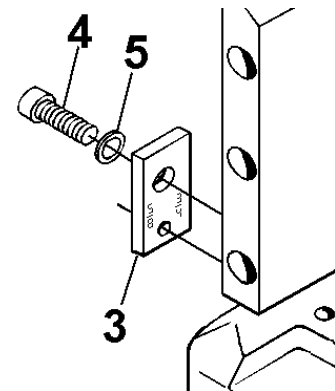

2. Install guide (Key 3) with text "5/8 3/4" facing outward from tool.

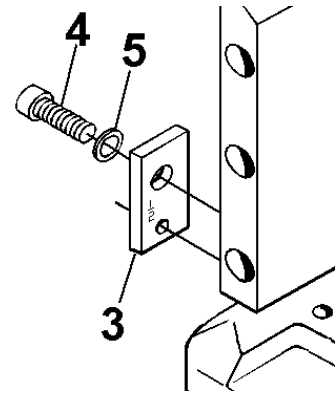

3. Install guide (Key 2) with text "1/2" facing outward from tool.

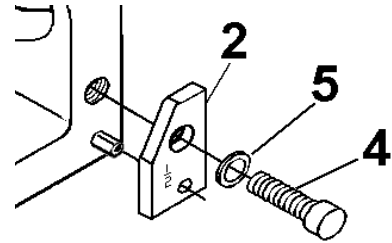

4. Install guide (Key 2) with text "5/8 3/4" facing outward from tool.

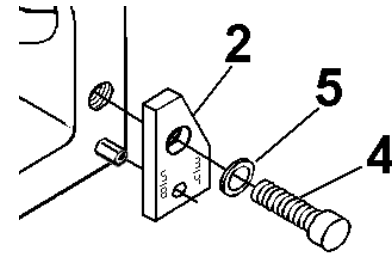

5. Install the guide (Key 26) in the inward position. Install the link (Key 34) in the outer position with the stem facing inwards.

NOTE: Always install guide (Key 26) with the chamfer facing out.

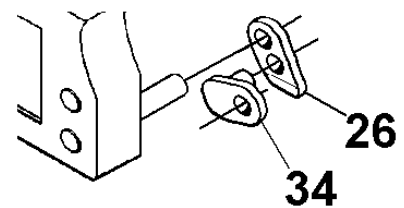

6. Install the guide (Key 26) in the outer position. Install the link (Key 34) in the inner position with the stem facing outwards.

NOTE: Always install guide (Key 26) with the chamfer facing out.

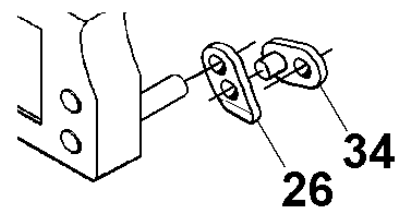

TOOL OPTIONS

STRAP DEFLECTOR (Part No. 424321)

The strap deflector (Key 68) is an optional part which is used to prevent the strap from curling around the feedwheel from severe high tension applications. The deflector is installed on the tool behind the back guide (Key 2) as shown using the existing hardware.

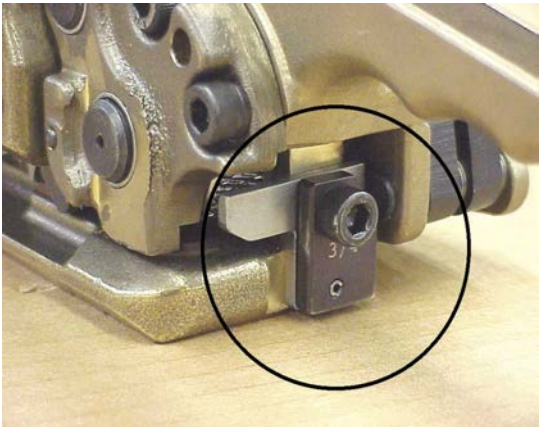

THE STRAP DEFLECTOR IS INSTALLED BEHIND THE BACK GUIDE.

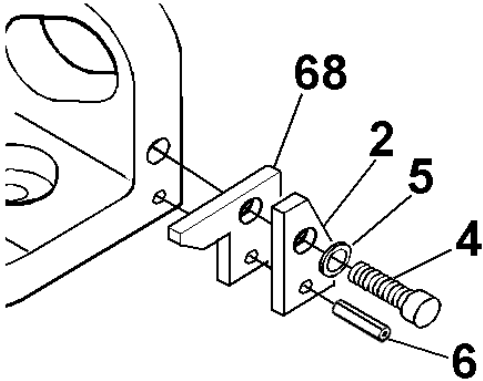

INSTALL THE DEFLECTOR USING THE EXISTING MOUNTING HARDWARE.



EU Declaration of Conformity
The Supply of Machinery (safety) Regulations
1992 (S.I. 1992/3073)

It is hereby declared that the undermentioned machinery has been designed and constructed to comply with the health and safety requirements defined in EC Directive 89/392/EEC

Machine Supplier: Signode, Division of ITW Ltd.
Queensway, Fforestfach
Swansea SA5 4ED

Machine Description: SCM

Machine Type: Manual Combination Hand Strapping tool.

Provisions with which machine complies:

89/393/EEC, 91/368/EEC,
92/c 252/03, SI 1992/3703

Harmonized EuroNorms with which machine complies:

EN 292:1, EN 292:2, EN 294,
Pr EN 614, Pr EN 979, Pr EN 1005

Technical Standards with which machine complies:

NA

Signature: 
(Peter Oseland)

Date: 1 AUG 2001

SIGNODE NEW TOOL WARRANTY

Signode Engineered Products Warrants that a new Signode strapping tool will operate per functional specifications for a period of sixty (60) days after the date of shipment to the owner's place of business. Normal wearing parts, as outlined in the Operation, Parts & Safety manual, are covered by a thirty (30) day warranty unless, in Signode's judgement, these parts have been subjected to abnormal or extreme usage. Signode's sole liability hereunder will be to repair or replace, without charge, F.O.B. Signode's Glenview, Illinois plant, any tool which proves to not operate per functional specifications within the stated period. Signode reserves the right to replace any tool which proves not to operate per functional specifications with a new or like-new tool of the same model if in Signode's judgement such replacement is appropriate. Any new replacement tool provided to an owner will carry a full sixty (60) day warranty. Any warranty repaired tool or like-new replacement tool will carry a warranty for the balance of the time remaining on the initial sixty (60) day warranty. This warranty will be extended to compensate for the time the tool is in Signode's possession for warranty repairs.

This warranty is void as to any tool which has been: (I) subjected to mis-use, misapplication, accident, damage, or repaired with other than genuine Signode replacement parts, (II) improperly maintained, or adjusted, or damaged in transit or handling; (III) used with improperly filtered, unlubricated air or improper strapping material, (IV) in Signode's opinion, altered or repaired in a way that affects or detracts from the performance of the tool.

SIGNODE MAKES NO WARRANTY, EXPRESSED OR IMPLIED, RELATING TO MERCHANTABILITY, FITNESS OR OTHERWISE EXCEPT AS STATED ABOVE AND SIGNODE'S LIABILITY AS ASSUMED ABOVE IS IN LIEU OF ALL OTHERS ARISING OUT OF OR IN CONNECTION WITH THE USE AND PERFORMANCE OF THE TOOL. IT IS EXPRESSLY UNDERSTOOD THAT SIGNODE SHALL IN NO EVENT BE LIABLE FOR ANY INDIRECT OR CONSEQUENTIAL DAMAGES INCLUDING, BUT NOT LIMITED TO, DAMAGES WHICH MAY ARISE FROM LOSS OF ANTICIPATED PROFITS OR PRODUCTION, SPOILAGE OF MATERIALS, INCREASED COSTS OF OPERATION OR OTHERWISE.

Considerable effort has been made to ensure that this product conforms to our high quality standards. However, should you experience any difficulties, please contact your Sales Representative providing samples and the manufacturing code specified on the tool.

Thank you for your help.

SIGNODE ENGINEERED PRODUCTS
Hand Tool Division
3620 W. Lake Avenue, Glenview, Illinois 60026

PART #	DESCRIPTION	AREA OF USE
LUBRICANTS		
008556	LS-1236 AIR LINE OIL	AIR MOTORS, AIR VALVES
177029	GEAR HOUSING GREASE	CLUTCH DRIVES, INTERNAL GEARS, GEAR SETS
422792	WHITE LUBRIPLATE GR-132 GREASE	PNEUMATIC PARTS, AIR CYLINDERS, AIR VALVES, O-RINGS
422793	BLACK LUBRIPLATE 3000W GREASE	MOVING EXTERNAL PARTS, JAWS, LINKS
425239	RED MOBILITH SHC 007 GREASE	INTERNAL GEARS
432322	EP ACCROLUBE GREASE	HIGH FRICTION CONTACT PARTS
ADHESIVES		
274111	LOCTITE #380 BLACK MAX	PERMANENT, FLAT SURFACE PART CONTACT
422794	LOCTITE #222 PURPLE	LOW STRENGTH, SCREWS 1/4" (6MM) OR SMALLER SIZES
422795	LOCTITE #242 BLUE	MEDIUM STRENGTH, SCREWS 5/16" (8MM) OR LARGER SIZES
422796	LOCTITE #271 RED	HIGH STRENGTH, SEMI-PERMANENTSCREW APPLICATION
422797	LOCTITE #609 GREEN	PERMANENT, CURVED SURFACE PART CONTACT
CLEANING BRUSHES		
023963	SMALL BRUSH	FEEDWHEEL & GRIPPER TEETH
269589	LARGE BRUSH	FEEDWHEEL & GRIPPER TEETH